

900 A/B

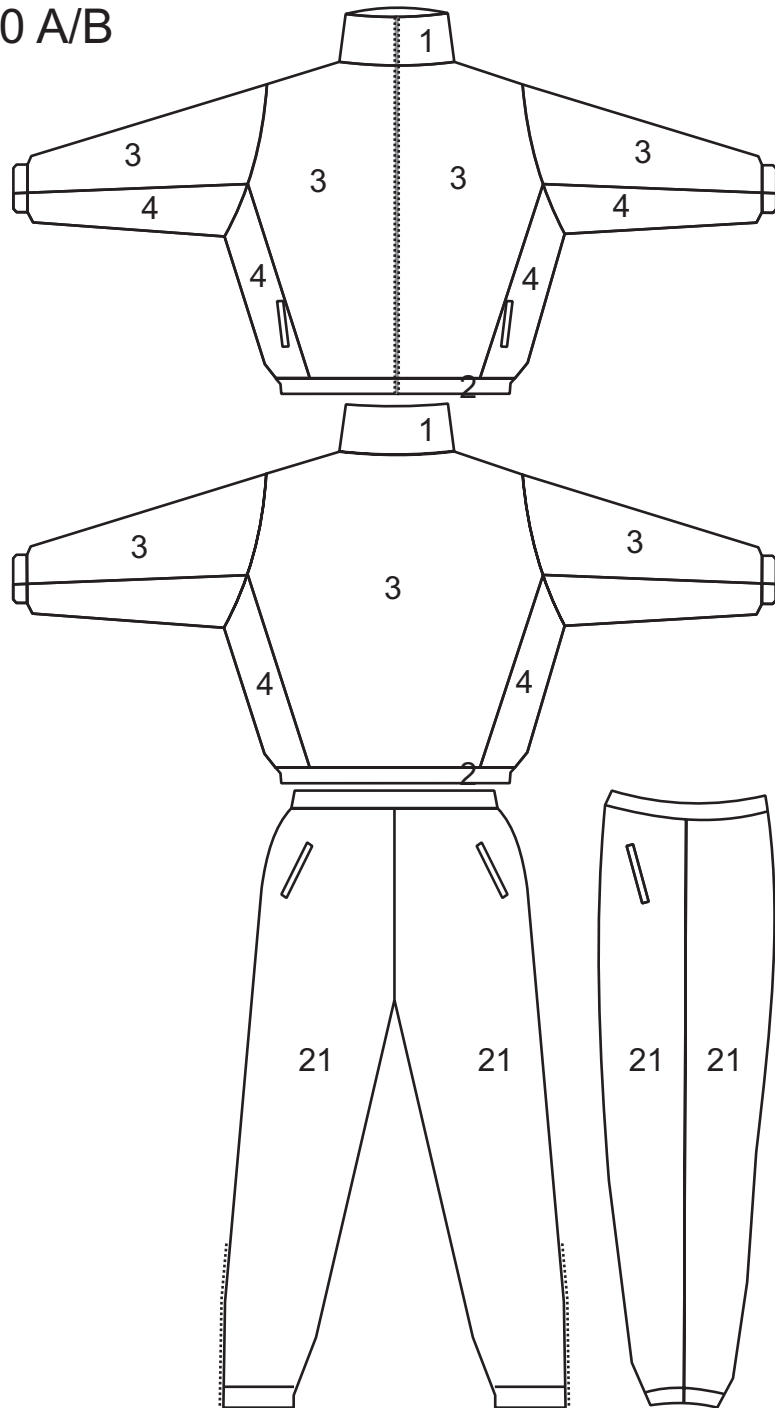

900 C/D

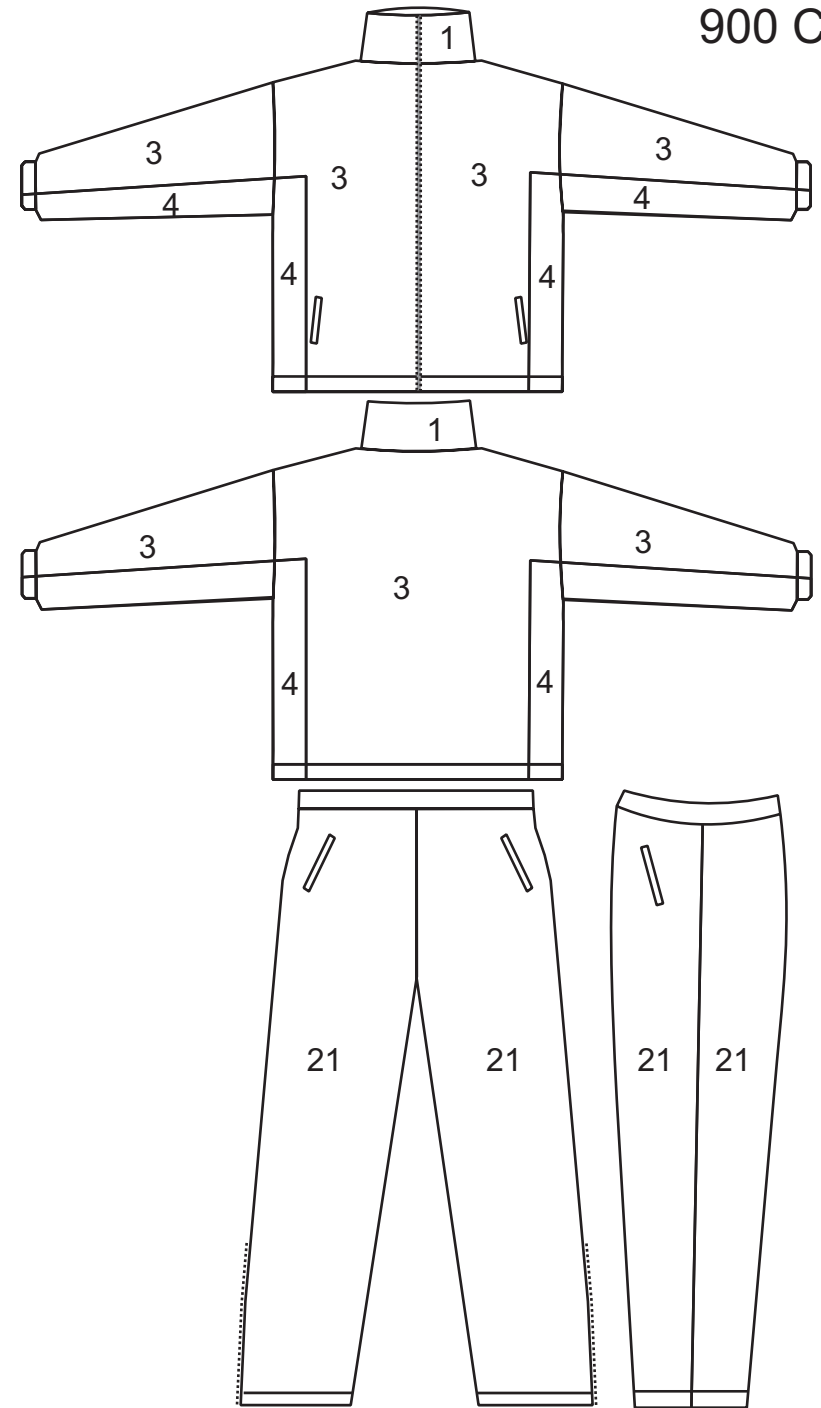

900 A/D

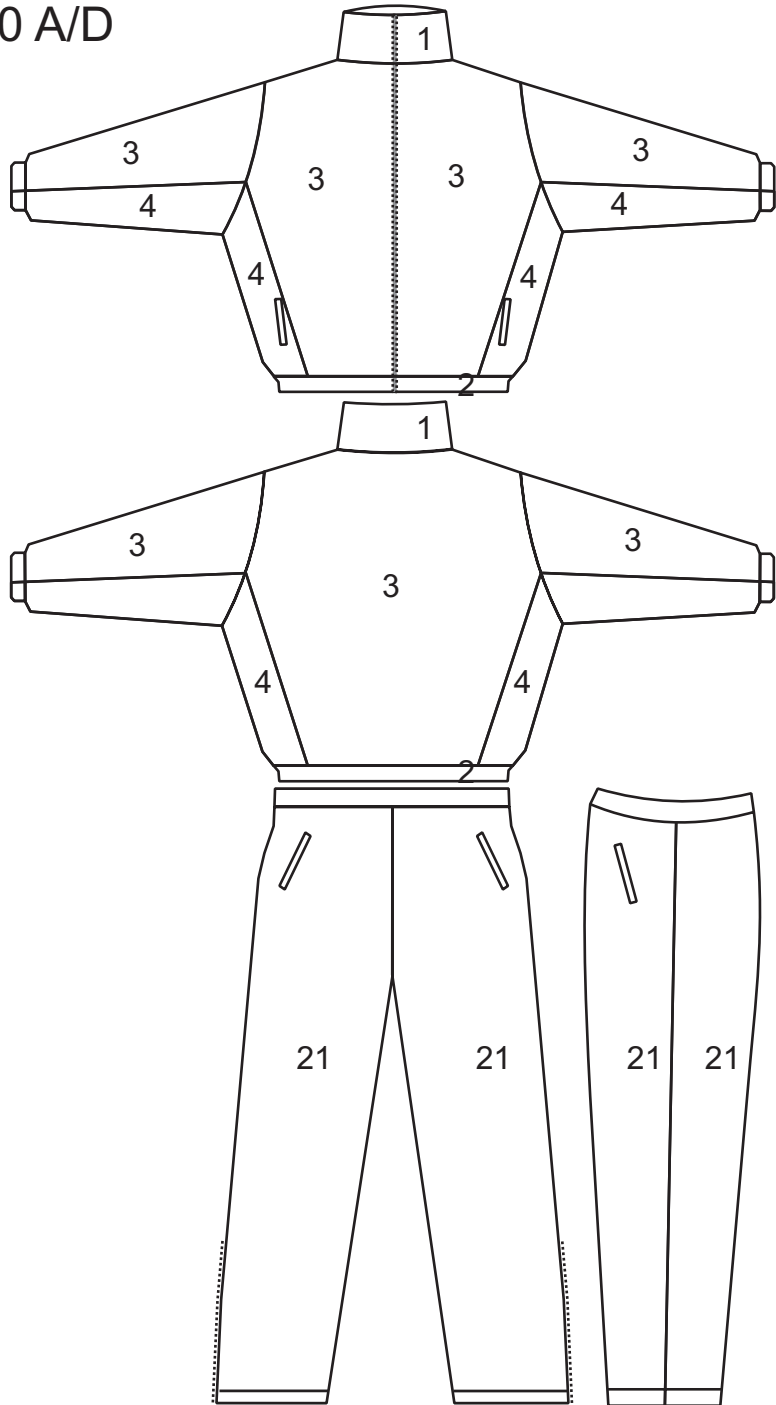

900 C/B

