

400 A/B

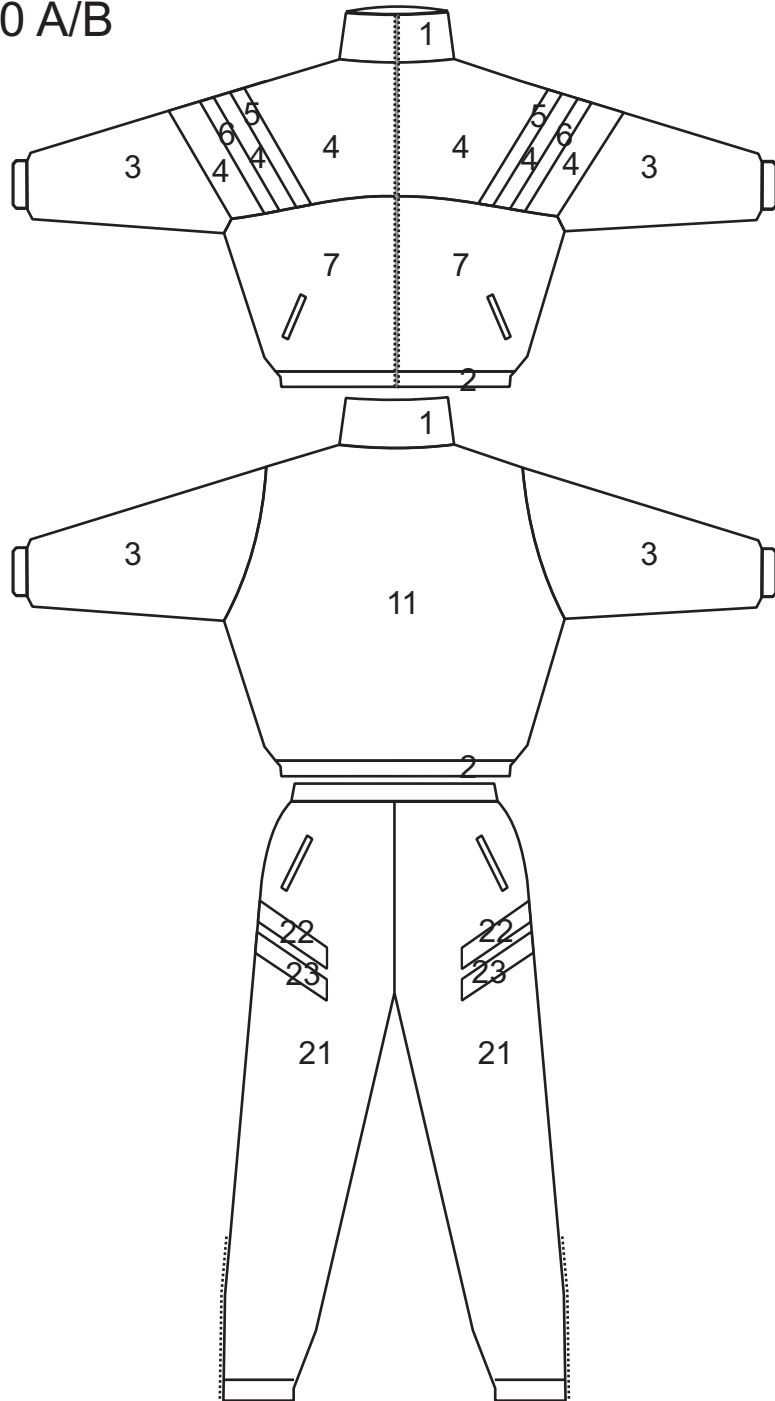

400 C/D

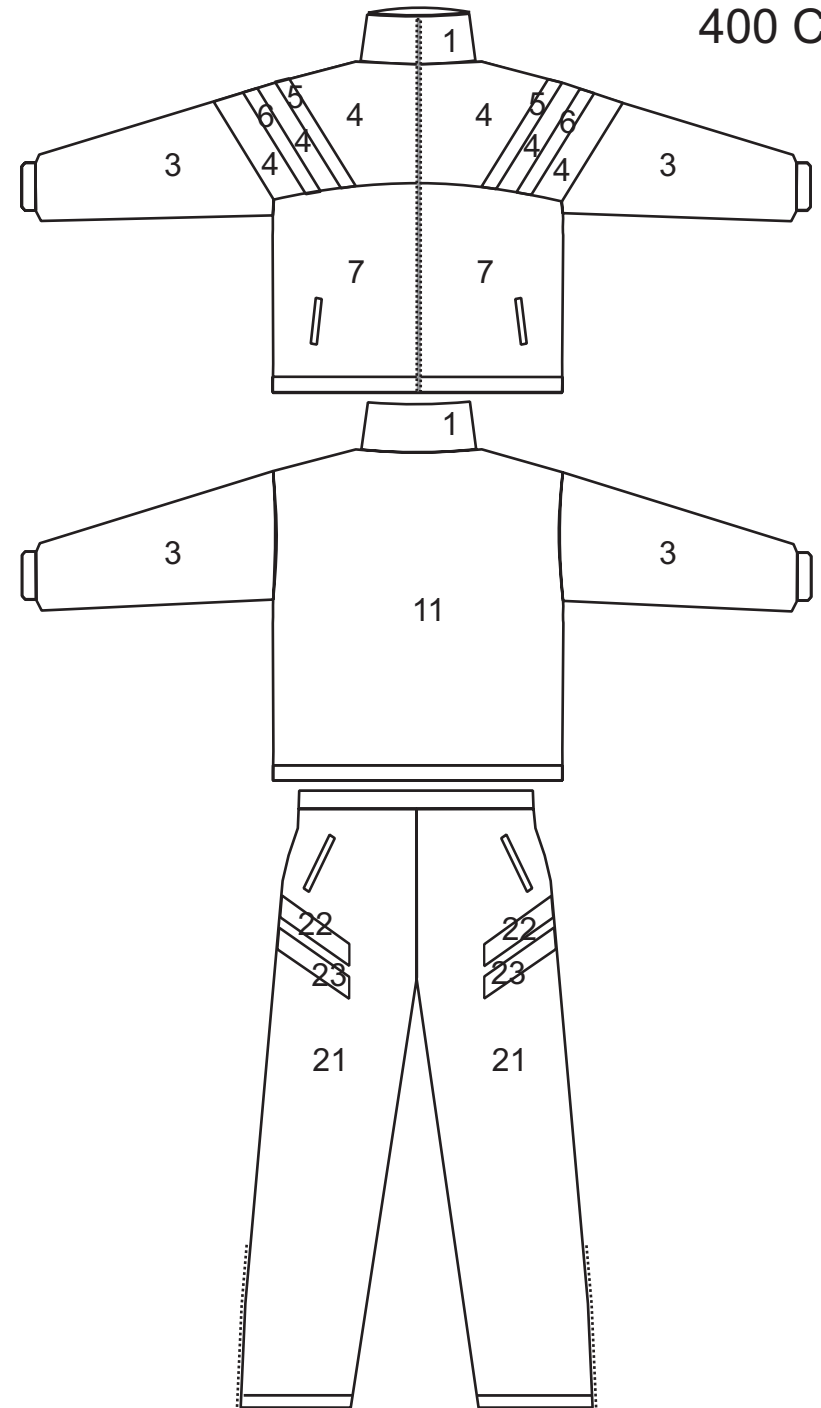

400 A/D

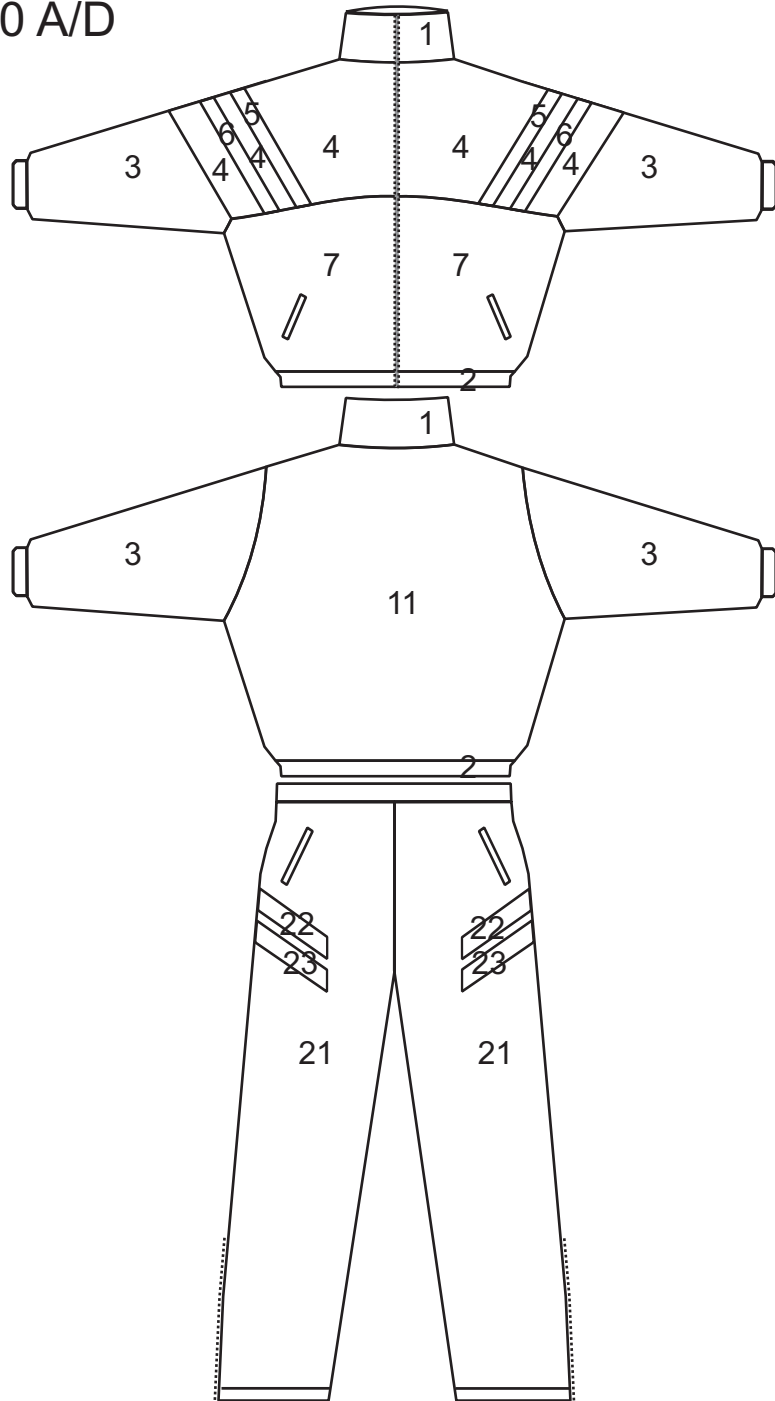

400 C/B

