

200 A/B

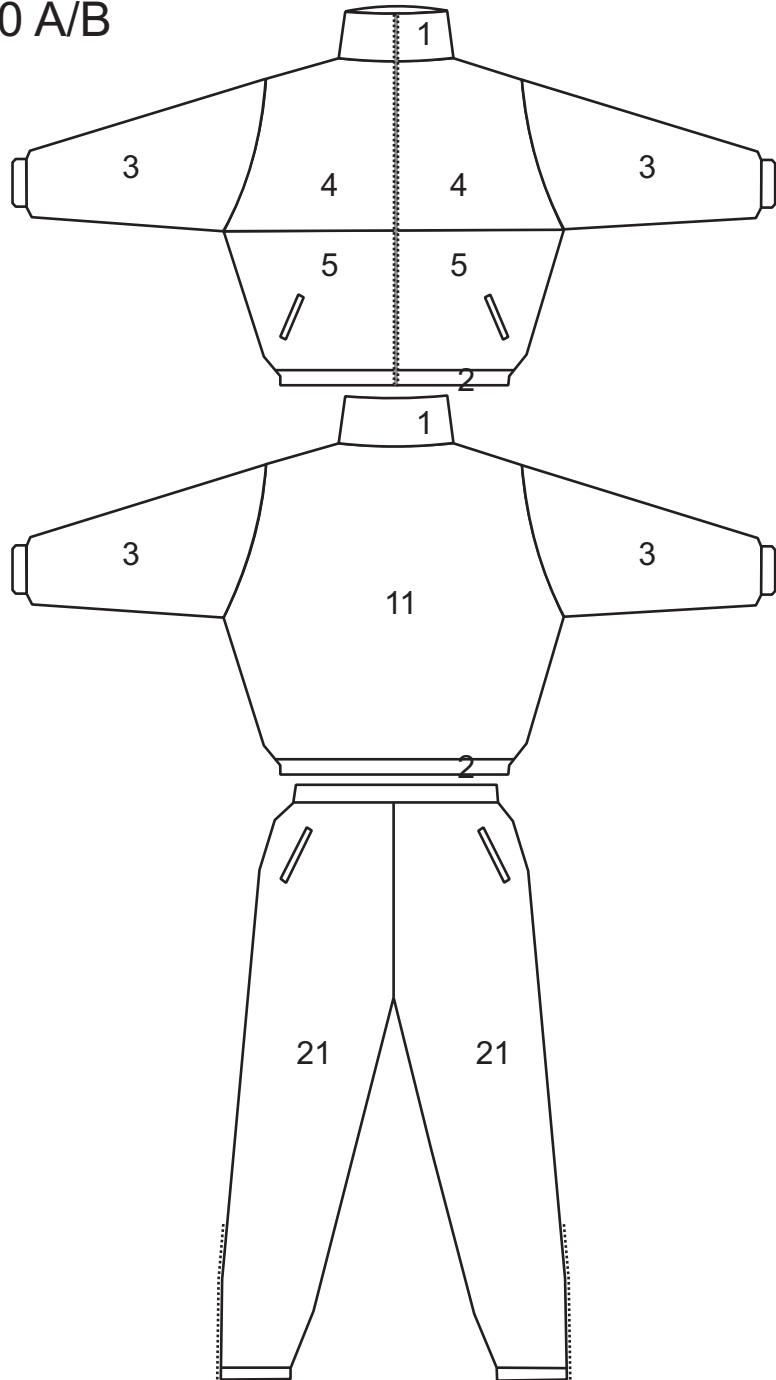

200 C/D

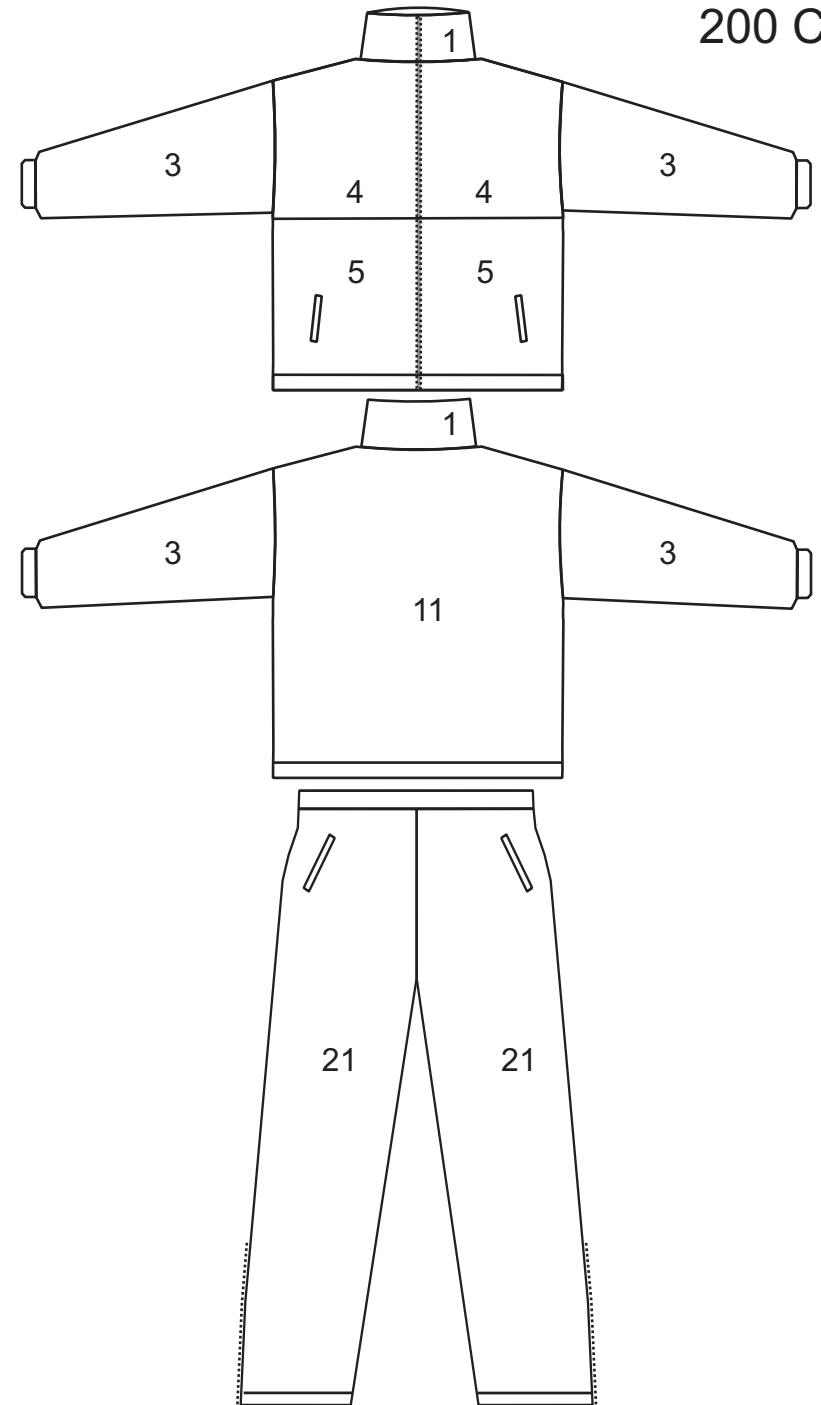

200 A/D

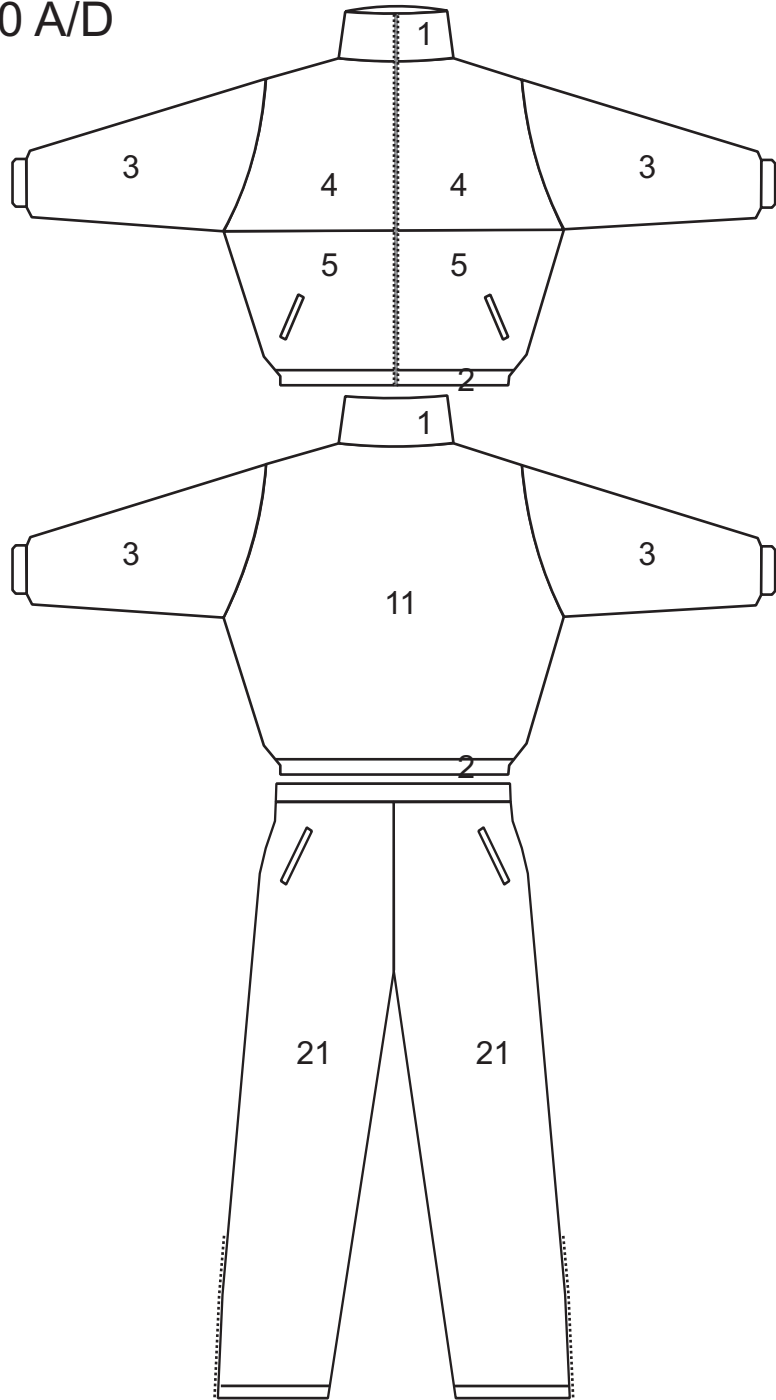

200 C/B

