

100 A/B

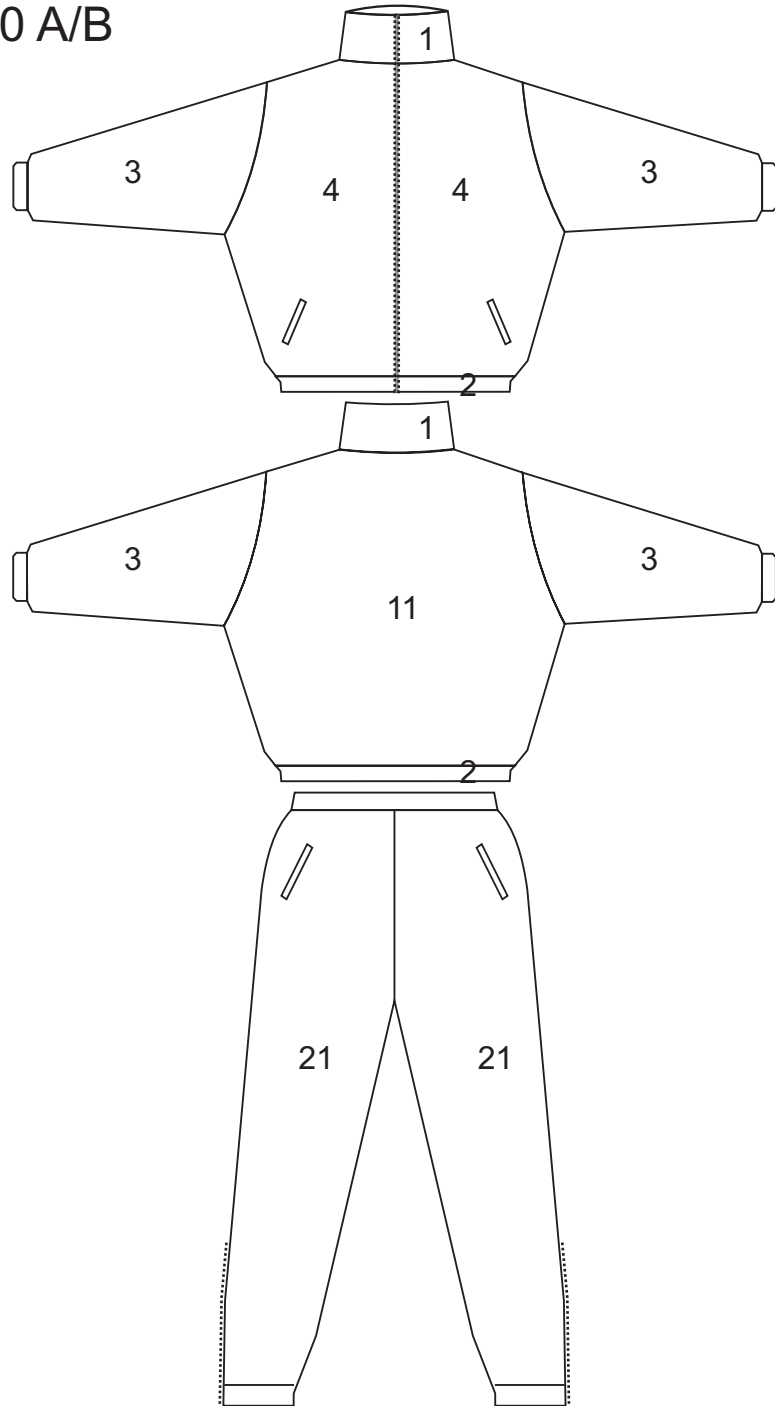

100 C/D

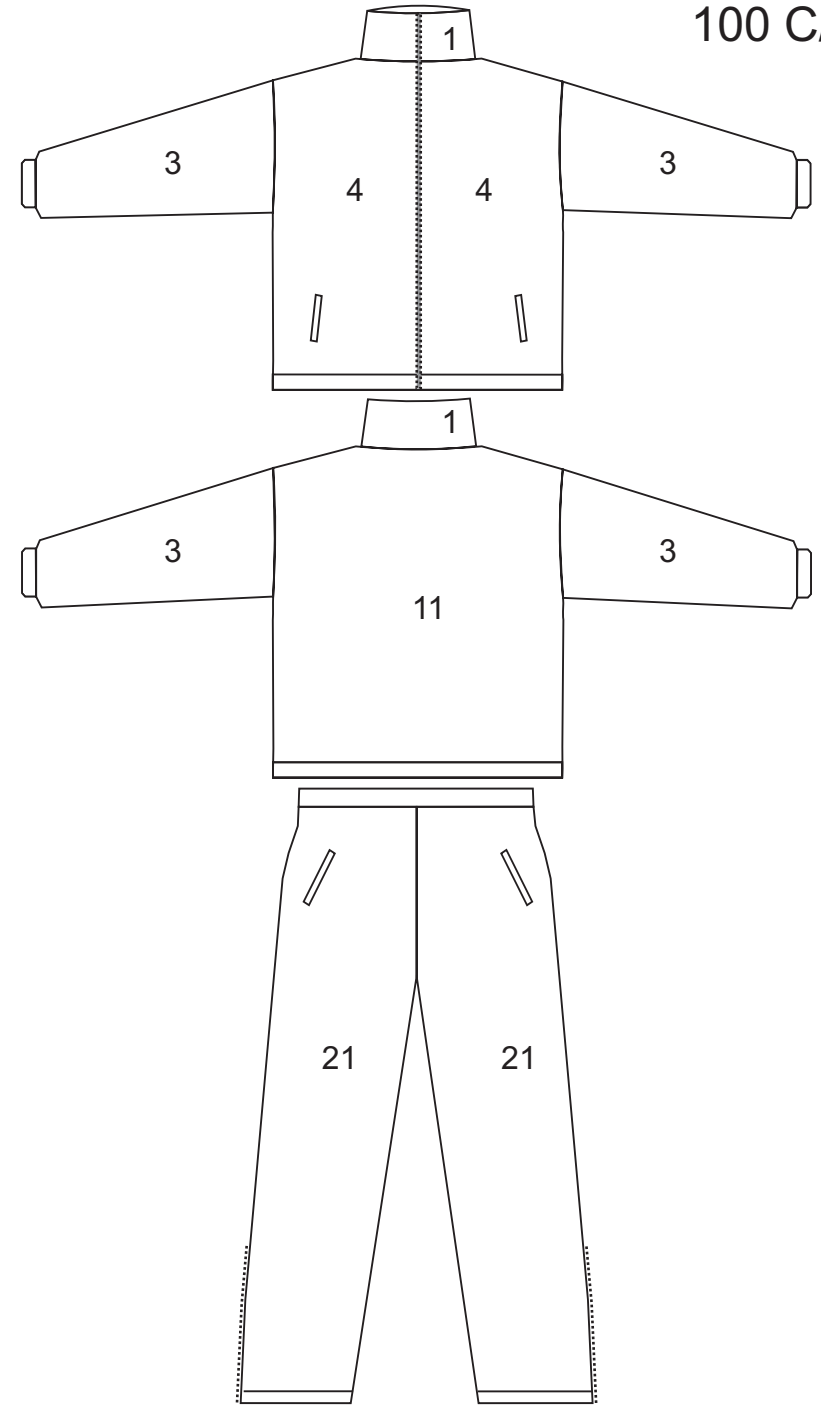

100 A/D

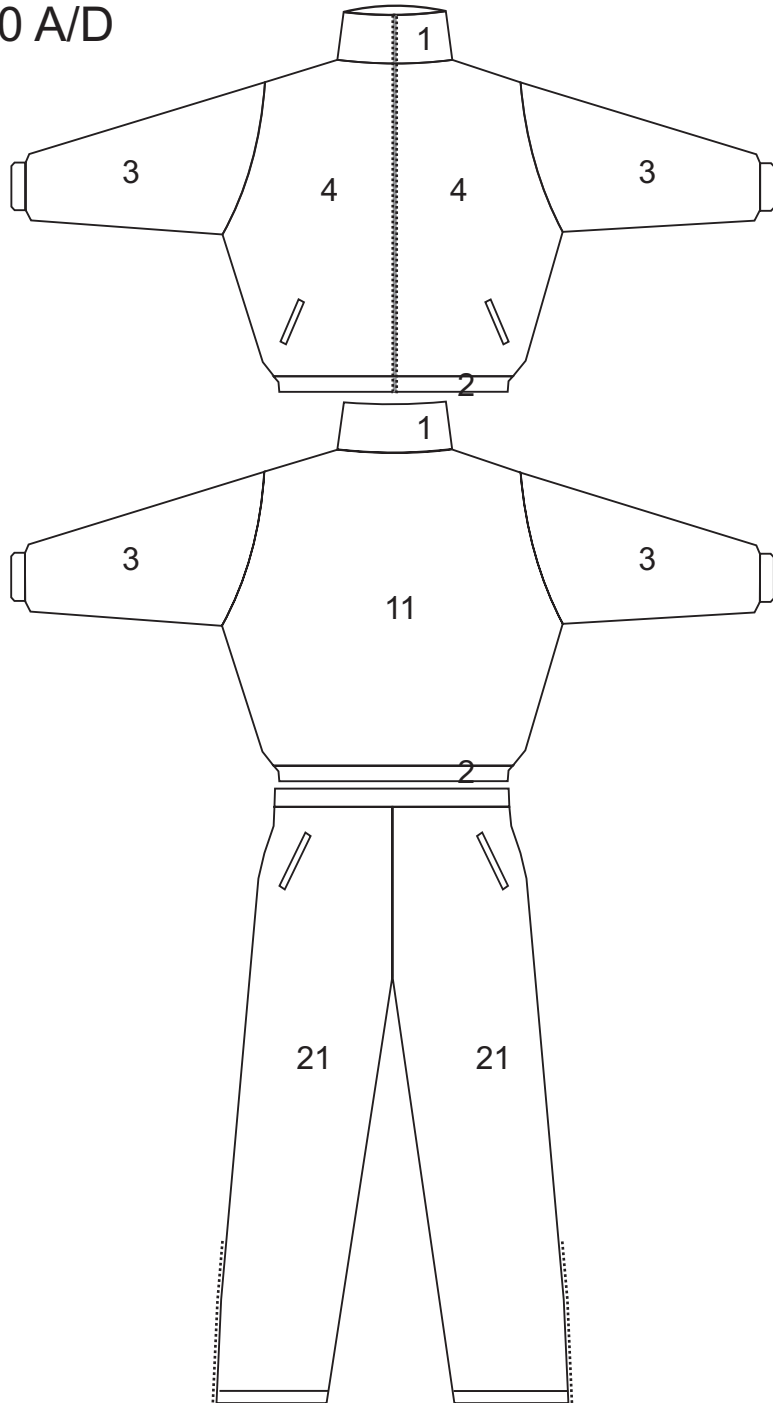

100 C/B

